

More Precision.

PSC-SSS-1M/2M

Precise non-contact temperature measurement from 250°C to 1800°C



FEATURES

- New: Infrared Thermometer with short wavelengths of 1.0 or 1.6 μm for measurement of metals, molten glass, composites and ceramic materials.
- Miniature sensing head of 14 mm diameter and 28 mm length - fits anywhere
- Ambient temperature rating of sensor head up to 125°C without cooling
- Temperature ranges from 250°C to 1800°C
- Small spot sizes down to 1.8 mm
- **Fast Response time of 1 ms**
- Short wave lengths of 1.0 and 1.6 μm reduce temperature errors on measured materials with low or unknown emissivity

General specifications	
Environmental rating	IP 65 (NEMA-4)
Ambient temperature	sensing head: -20 - 100°C (1M) / 125°C (2M) electronics: 0 - 85°C
Storage temperature	sensing head: -40 - 100°C (1M) / 125°C (2M) electronics: -40 - 85°C
Relative humidity	10 - 95 %, non condensing
Vibration (sensor)	IEC 68-2-6: 3 G, 11-200 Hz, any axis
Shock (sensor)	IEC 68-2-27: 50 G, 11 ms, any axis
Weight	sensing head 40 g electronics 420 g
Electrical specifications	
Outputs/analog	0/4 - 20 mA, 0 - 5/10 V, thermocouple J, K, alarm
Alarm output	Open - collector (24V/50mA)
Optional:	relay: 2 x 60 V DC/42 V AC _{eff} ; 0.4 A; optically isolated
Outputs/digital (optional)	USB, RS232, RS485, CAN, Profibus DP, Ethernet
Output impedances	mA max. 500 Ω (with 8 - 36 V DC) mV min. 100 k Ω load impedance thermocouple 20 Ω
Inputs	programmable functional inputs for external emissivity adjustment, ambient temperature compensation, trigger (reset of hold functions)
Cable length	3 m (standard), 8 m, 15 m
Current draw	max. 100 mA
Power supply	8 - 36 V DC

Measurement specifications	
Temperature ranges (scalable via programming keys or software)	485 - 1050°C (1ML)
	650 - 1800°C (1MH)
	250 - 800°C (2ML)
	385 - 1600°C (2MH)
Spectral ranges	1.0 μm (1M) / 1.6 μm (2M)
Optical resolution SSS-1ML/2ML	40:1 (3.5mm@140mm)
Optical resolution SSS-1MH/2MH	75:1 (0.8mm@140mm)
System accuracy ¹⁾ (at ambient temperature 23 \pm 5°C)	\pm (0.3% of reading + 2°C)
Repeatability (at ambient temperature 23 \pm 5°C)	\pm (0.1% of reading + 1°C)
Temperature resolution (digital)	0.1 K
Exposure time ²⁾	1 ms (90 %)
Emissivity/Gain (adjustable via programming keys or software)	0.100 - 1.100
Transmissivity/Gain (adjustable via programming keys or software)	0.100 - 1.100
Signal processing (parameter adjustable via programming keys or software, respectively)	peak hold, valley hold, average; extended hold function with threshold and hysteresis

¹⁾ E=1, Response time 1 s

²⁾ with dynamic adaptation at low signal levels

PSC-SSS-1M/2M

Optical specifications

SSS 1ML/2ML SF (Std. Focus) D:S = 40:1

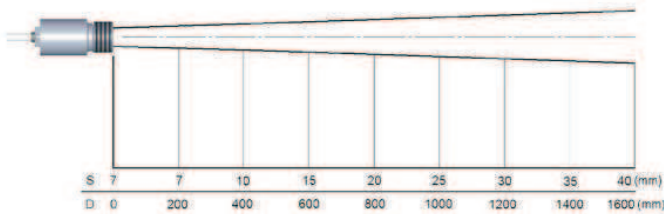

SSS 1MH/2MH SF (Std. Focus) D:S = 75:1

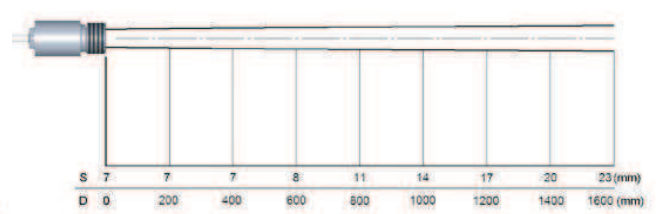

SSS 1ML/2ML CF (Close Focus) D:S = 40:1 (far field 12:1)

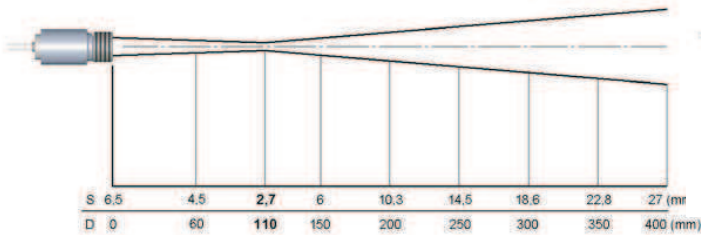

SSS 1MH/2MH CF (Close Focus) D:S = 75:1 (far field 14:1)

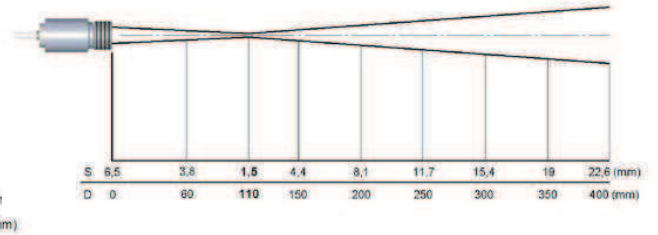

Dimensions

Sensing head

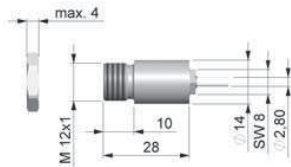

Electronics

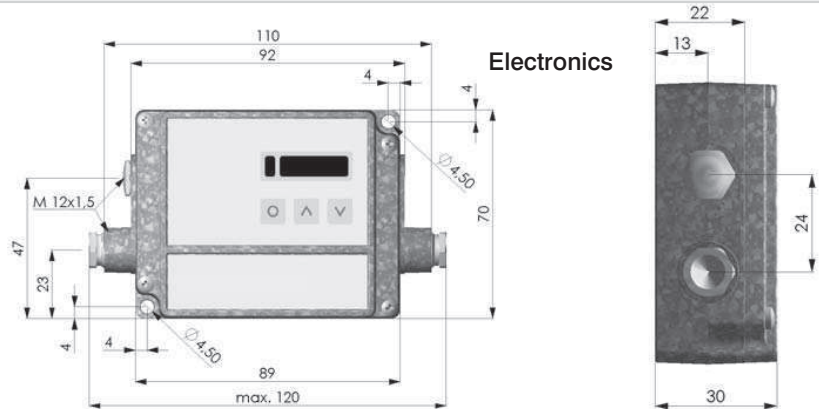

PSC CompactConnect Software

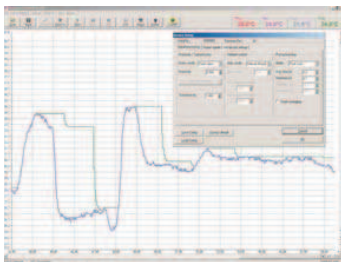

- Software for easy sensor setup and remote controlling, supports multi tasking
- Graphic display for temperature trends and automatic data logging for analysis and documentation with 1 ms response time
- Adjustment of signal processing functions and programming of outputs and functional inputs of the sensor
- Automatic emissivity adjustment
- PSC CompactConnect software allows to customize the sensor the application needs of the user